

CODISPLAY: BCD PARALLEL

ART. No. 190001B

DIP SELECTABLE AS EITHER 4 OR 6 DISPLAYED LED DIGITS

14MM 7-SEGMENT LEDs

CHARACTERS "0123456789-EHLP"

RED CONTRAST FILTER

BCD INTERFACE (PARALLEL)

PANEL MOUNTING

FRONT IP65 PROTECTED



CONTENTS	PAGE
1. DIP SWITCH SETTINGS	2
2. INDICATOR NUMBERING	3
3. PARAMETRIC BYTE	3
4. SIGNAL INPUTS	5
5. POWER SUPPLY	6
6. INDICATOR TEST	6
7. CE CONFORMITY AND ROHS COMPLIANCE	6
8. PANEL MOUNTING	7
A. EXAMPLES	8

1. DIP SWITCH SETTINGS:

SW1: FUNCTIONAL DIP SWITCH

SW1-1, SW1-2 , SW1-3
LED brightness control.

Brightness		SW1 -1	SW1-2	SW1-3
2 %	lowest	OFF	OFF	OFF
10 %		ON	OFF	OFF
15 %		OFF	ON	OFF
25 %		ON	ON	OFF
35%		OFF	OFF	ON
50 %		ON	OFF	ON
75 %		ON	ON	OFF
98%	highest	ON	ON	ON

Table 1

SW1-4 – Entry mode.

When is OFF Indicators is addressed from left to right.

When is ON Indicators is addressed from right to left.

SW1-5

4 or 6 displayed LED digits.

ON: 4 displayed digits

OFF: 6 displayed digits.

SW1-6

Display initial setting

ON: All digits display **0** after power up.

OFF: Blank display after power up.

Note: The DIP Switch settings must only be changed when the power to the device is turned off. The DIP Switch settings come into effect on power up.

2. INDICATOR NUMBERING

The following figure shows the numbering of indicators from left to right.

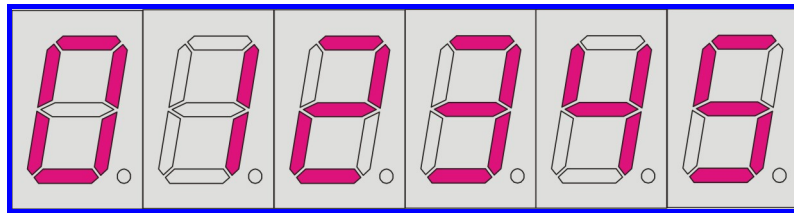

Figure 1

3. PARAMETRIC BYTE

The data at the input are displayed in decimal format. This requires the **CS** signal (Chip Select) to be activated. As soon as the data and the address signals are stable, the read and display cycle is triggered by the rising edge of the **RS** (Register Select) signal. Refer to figure 2. The new data appears on display when both signals, **CS** and **RS**, are low.

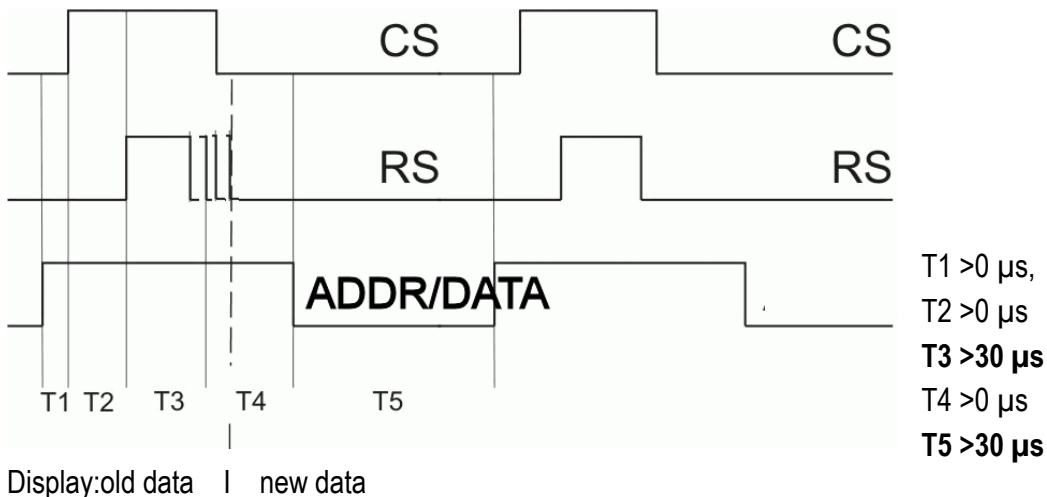

Figure 2

The Parametric Byte contains the information about the decimal point, the address and data. Figure 3 shows the structure of the Parametric Byte.



Figure 3

DECIMAL POINT: The decimal point is set with bit 3 of the upper nibble of the Parametric Byte.

ADDRESS RANGE: Each Indicator is addressed via Bits 4, 5 and 6 of the upper nibble of the Parametric Byte. The address can be in the range from 0hex (1st indicator depending of position of SW1-4) to 5hex (last indicator depending of position of SW1-4) for 6 displayed digits. In the 4 digit mode the address range is from 0hex (indicator 1) to 3hex (indicator 4).

DATA: The data can be in range from 0hex to Fhex and occupies the lower nibble of Parametric Byte. Figure 4 shows all combinations from 0hex to Fhex.







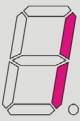
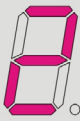
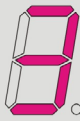
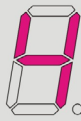

							
0h	1h	2h	3h	4h	5h	6h	7h
							
8h	9h	Ah	Bh	Ch	Dh	Eh	Fh

Figure 4

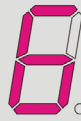
Data Bit Codes:

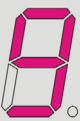
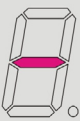
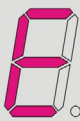
Data bit 0	0	1	0	1	0	1	0	1	0	1	0	1	0	1	0	1
Data bit 1	0	0	1	1	0	0	1	1	0	0	1	1	0	0	1	1
Data bit 2	0	0	0	0	1	1	1	1	0	0	0	0	1	1	1	1
Data bit 3	0	0	0	0	0	0	0	1	1	1	1	1	1	1	1	1
Hex.	0h	1h	2h	3h	4h	5h	6h	7h	8h	9h	Ah	Bh	Ch	Dh	Eh	Fh

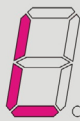
Table 3

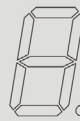
Character displayed:















							
0h	1h	2h	3h	4h	5h	6h	7h
							
8h	9h	Ah	Bh	Ch	Dh	Eh	Fh

Figure 5

DATA AND COMMAND SEQUENCE:

Each digit has to be set separately with the following sequence:

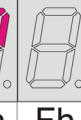
- Apply signals Data at the inputs D0 to D3, the address at AD0 to AD2 and the decimal point at AD3.
 - Hold signals D and AD stable and apply the control signals CS and RS as described in figure 2.
- Repeat this sequence for each digit.

EXAMPLE 1:

Display “1234.56” in 6 digit mode:

Set SW1-4 – OFF – set entry mode left to right

Set SW1-5 – OFF – set 6 digit mode

Set SW1-6 – ON – All digits display 0 after power up.

Turn power on.

- Apply sequence: 01
- apply control signals CS and RS as described in figure 2.
- Apply sequence: 12
- apply control signals CS and RS as described in figure 2.
- Apply sequence: 23
- apply control signals CS and RS as described in figure 2.
- Apply sequence: B4
- apply control signals CS and RS as described in figure 2.
- Apply sequence: 45
- apply control signals CS and RS as described in figure 2.
- Apply sequence: 56
- apply control signals CS and RS as described in figure 2.

If the SW1-4 is set to ON Codisplay will point **654.321**

4. SIGNAL INPUTS

Terminal X3/	Symbol	Description	Signal
1	GND	Signal Earth	0 VDC
2	D0	data bit 0	24 VDC
3	D1	data bit 1	24 VDC
4	D2	data bit 2	24 VDC
5	D3	data bit 3	24 VDC
6	AD0	address bit 0	24 VDC
7	AD1	address bit 1	24 VDC
8	AD2	address bit 2	24 VDC
9	AD3	decimal point	24 VDC
10	R/W	Read/write signal	24 VDC
11	CS	Chip select signal	24 VDC
12	RS	Register select signal	24 VDC

Table 5

X3/1 to X3/12:

Spring terminal connection for conductors with cross section of 0.14 mm² to 0.5 mm² / AWG 26 to AWG 20

NOTE: The presentation of a signal >16 VDC on any of the signal terminals is converted to a binary 1 (ON), signals of <3 VDC are converted to binary 0 (OFF).

5. POWER SUPPLY

The power supply must be in range from 16 VDC up to 30 VDC / 1A. Codisplay is protected against improper power supply connection.

X1/1 = Vin +ve of DC source (square pad) marked on PCB as "+8..24V"

X1/2 = GND -ve of DC source (round pad) marked on PCB as "GND"

X1/1 and X1/2:

Spring terminal connection for conductors with cross section of 0.14 mm² to 0.5 mm² / AWG 26 to AWG 20

Power supply consumption Codisplay			
	PWM 0%	PWM 50%	PWM 98%
Voltage 24V	15 mA	38 mA	60 mA

Table 6

Measurements were made with all LED segments and decimal points switched on.

6. INDICATOR TEST

The Indicator test can be performed at any time using jumper **JP3**.

7. CE CONFORMITY AND ROHS COMPLIANCE

Crameda AG declares that Codisplay 190001B complies with the requirements for CE conformity. However this can only be maintained by complying with the following installation instructions:

1. The signal cable must not exceed 1 metre.
2. The signal cable must be supplied via a current compensating single-aperture core filter to the Codisplay. Signal lines must be wound with the same alignment (angular) with at least 2 windings on the filter.

All PCB boards, components and solder paste are manufactured with leadless technology and meet the requirements for RoHS Environment friendly fabrication.

8. PANEL MOUNTING

PANEL CUTOUT:

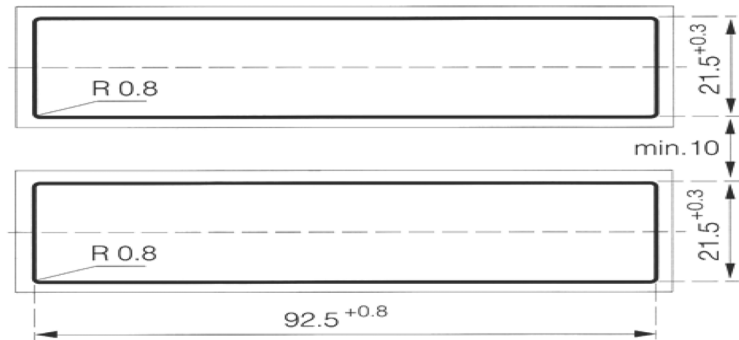

Millimetres	Inches
92.5	3.642
21.5	0.846

DIMENSIONS:

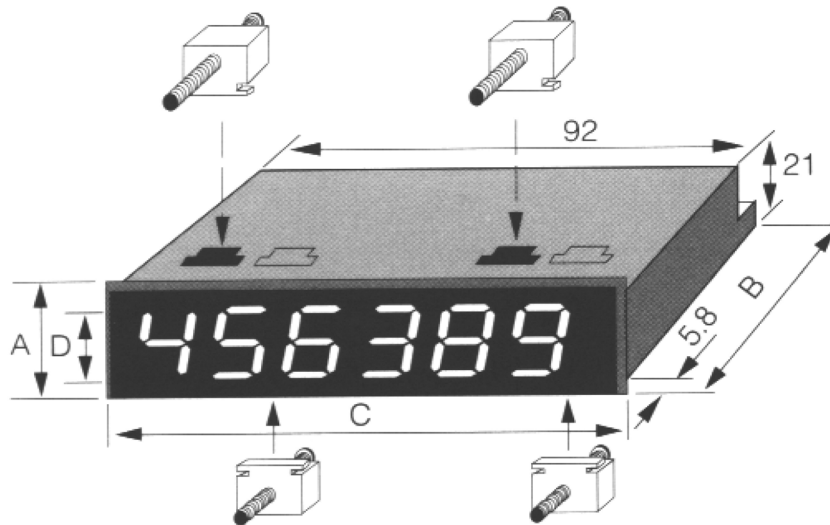

Dimension	Description	Millimetres	Inches
A	Height	24	0.945
B	Depth	108	4.252
C	Width	96	3.780
D	LED	14	0.551

Weight approx. 130 grams

Specifications are subject to change without notice.

A. EXAMPLES

EXAMPLE 1 IN DETAIL:

Display “1234.56” in 6 digit mode:

- Turn power off, set SW1-1 to SW1-3 to ON, SW1-4 to SW1-6 to OFF, turn power on.
- Apply sequence: 01 “%” 12 “%” 23 “%” B4 “%” 45 “%” 56 “%” at the inputs.
- “%” = apply control signals CS and RS as described in the figure 2.

For details see table 4

Signal	Control			DP	Address				Data				Hex
	RS	CS	R/W	AD3	AD2	AD1	AD0	D3	D2	D1	D0		
Terminal No	12	11	10	9	8	7	6	5	4	3	2		
Step													
1	0	0	0	0	0	0	0	0	0	0	1	01	
2	“%”	“%”	0	stable state									1
3	0	0	0	0	0	0	1	0	0	1	0	12	
4	“%”	“%”	0	stable state									1 2
5	0	0	0	0	0	1	0	0	0	1	1	23	
6	“%”	“%”	0	stable state									1 2 3
7	0	0	0	1	0	1	1	0	1	0	0	B4	
8	“%”	“%”	0	stable state									1 2 3 4.
9	0	0	0	0	1	0	0	0	1	0	1	45	
10	“%”	“%”	0	stable state									1 2 3 4. 5
11	0	0	0	0	1	1	0	0	1	1	0	56	
12	“%”	“%”	0	stable state									1 2 3 4. 5 6

0 = signal of <8 VDC

1 = signal of >12 VDC

“%” = apply control signals CS and RS as described in the figure 2

Table 4

EXAMPLE 2:

Change Display “1234.56” to “123.--” in 6 digit mode:

- For CODISPLAY 190001 apply sequence: A3 “%” 3E “%” 4E “%” 5F “%” at the inputs.
- For CODISPLAY 190001B apply sequence: A3 “%” 3A “%” 4A “%” 5F “%” at the inputs.

EXAMPLE 3:

Display “-1.09” in 4 digit mode:

- Turn power off, set SW1-1 to SW1-3 and SW1-5 to ON, SW1-4 and SW1-6 to OFF, turn power on.
- For CODISPLAY 190001 apply sequence: 0E “%” 91 “%” 20 “%” 39 “%” at the inputs.
- For CODISPLAY 190001B apply sequence: 0A “%” 91 “%” 20 “%” 39 “%” at the inputs.